

### Analog Peripherals

#### 12-Bit ADC, 5 V input signal; up to 16 external inputs

- $\pm 1$  LSB INL; guaranteed monotonic
- Programmable throughput up to 200 ksps
- Data-dependent windowed interrupt generator
- Programmable gain maximizes input signal span

#### Built-in Temperature Sensor ( $\pm 3$ °C)

#### One Comparator

#### Internal Voltage Reference

#### Precision $V_{DD}$ Monitor/Brown-out Detector

#### On-Chip Debug

- On-chip debug circuitry facilitates full speed, non-intrusive in-system debug (no emulator required)
- Provides breakpoints, single stepping, watch-points
- Inspect/modify memory, registers, and stack
- Superior performance to emulation systems using ICE-chips, target pods, and sockets

#### Supply Voltage: 2.7 to 5.25 V

- Typical operating current: 7 mA at 25 MHz at 5.0 V
- Multiple power saving sleep and shutdown modes

#### Temperature Range: -40 to +125 °C

### High-Speed 8051 $\mu$ C Core

- Pipelined instruction architecture; executes 70% of instructions in 1 or 2 system clocks
- Up to 25 MIPS throughput with 25 MHz system clock
- Expanded interrupt handler

### Memory

- 4 kB Flash; in-system programmable; flexible security features
- 256 bytes data RAM

### Digital Peripherals

- Up to 16 digital I/O; all are 5 V push-pull
- Programmable 16-bit counter array with three capture/compare modules
- Three general-purpose 16-bit counter/timers
- Dedicated watchdog timer; bidirectional reset
- Real-time clock mode using timer 3 or PCA

### Clock Sources

- High-precision internal programmable oscillator up to 25 MHz
- External oscillator: Crystal, RC, C, or Clock

### Packages

- 20-Pin TSSOP and 20-Pin QFN (4x4 mm)

### Ordering Part Numbers

- C8051F534-IT (TSSOP)
- C8051F534-IM (QFN)

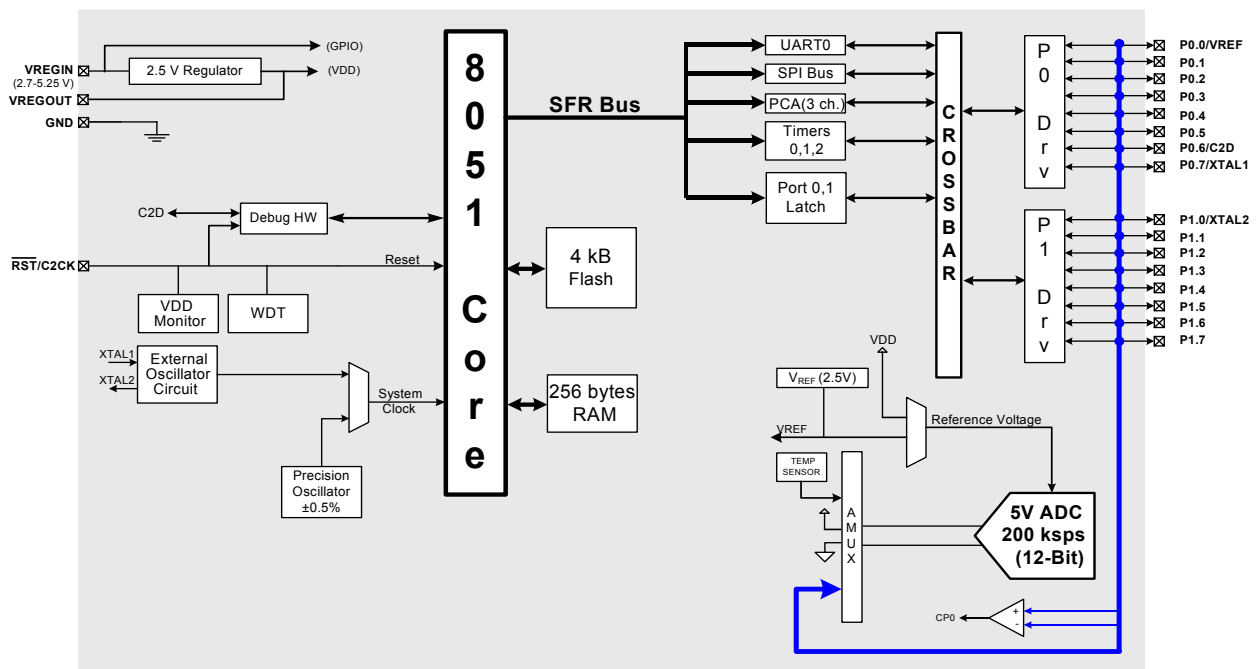

### Selected Electrical Specifications

( $T_A = -40$  to  $+125$  °C,  $V_{REGIN} = 2.7$  V unless otherwise specified)

Parameter	Conditions	Min	Typ	Max	Units
<b>Global Characteristics</b>					
Supply Voltage ( $V_{REGIN}$ )		2.7	—	5.25	V
Supply Current (CPU active) $V_{REGIN} = 2.7$ – $5.0$ V	Clock = 25 MHz	—	7	—	mA
	Clock = 1 MHz	—	0.8	—	mA
	Clock = 32 kHz; $V_{DD}$ monitor enabled	—	33	—	$\mu$ A
Supply Current (shutdown)	Oscillator not running; $V_{DD}$ monitor disabled	—	0.2	—	$\mu$ A
Clock Frequency Range		dc	—	25	MHz
<b>A/D Converter</b>					
Resolution			12		bits
Integral Nonlinearity		—	—	$\pm 1$	LSB
Differential Nonlinearity	Guaranteed monotonic	—	—	$\pm 1$	LSB
Signal-to-Noise Plus Distortion		—	68	—	dB
Throughput Rate		—	—	200	ksps
Input Voltage Range		0	—	$V_{REF}$	V
<b>Flash</b>					
Endurance		40K	150K	—	E/W cycles
Erase Cycle Time		10	12	14	ms
Write Cycle Time		40	50	60	$\mu$ s

### Package Information

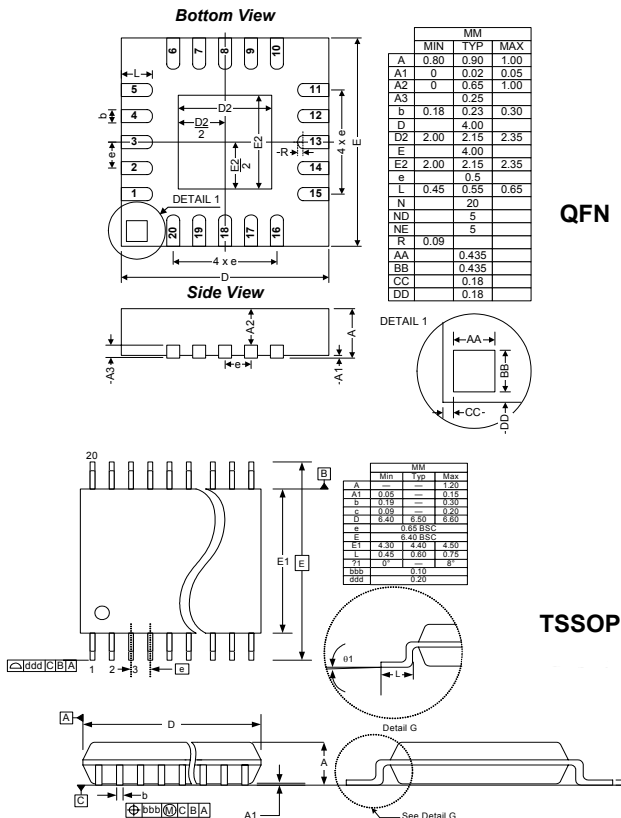

### C8051F530DK Development Kit

